

Impact of Traffic Aggregation on Network Capacity and Quality of Service

Towela Nyirenda-Jere (towela@ittc.ukans.edu)

Information and Telecommunications Technology Center

University of Kansas

[http:// www.ittc.ukans.edu](http://www.ittc.ukans.edu)

Outline

- Introduction and Motivation
- Network Calculus
- Single-Link Analysis
- Network Analysis
- Sensitivity Analysis
- Significance
- Future Work

Introduction and Motivation

Introduction

- Evolution of Internet from research to commercial
- Growth in volume and diversity of traffic
 - => redesign of Internet architecture
 - => revision of engineering rules

Introduction and Motivation

The Network Spectrum

- Aggregate handling + abundant capacity
- Semi-aggregate handling + simpler traffic management + moderate capacity
- Per-flow handling + complex traffic management + minimal capacity

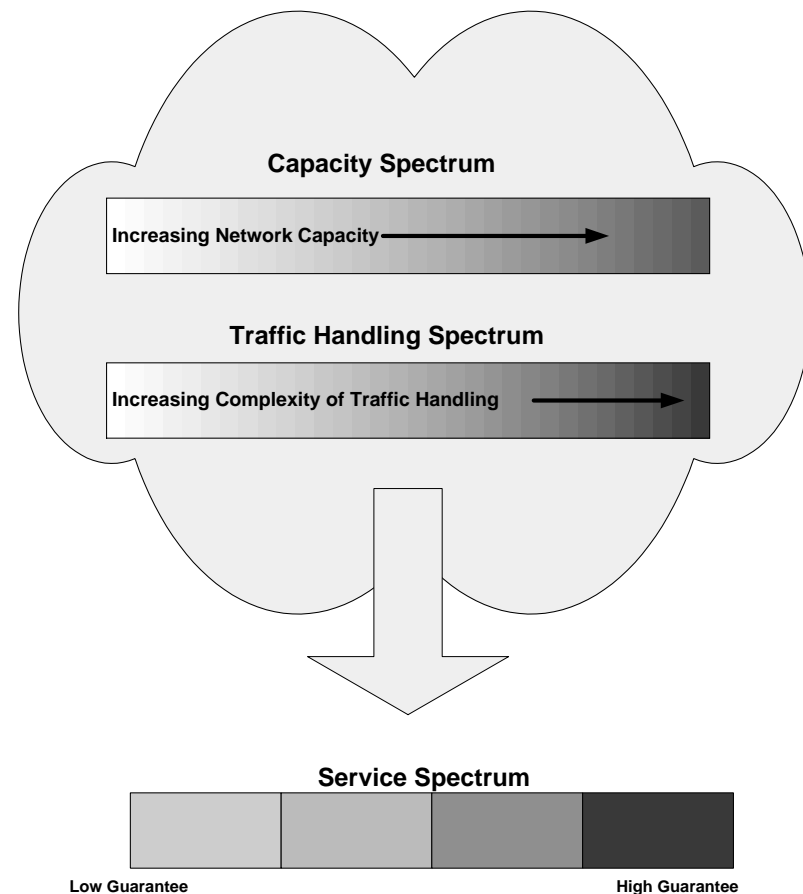

Introduction and Motivation

The Problem

- given the varying levels of complexity and differing capacity requirements of aggregate, semi-aggregate and per-flow traffic handling, how can one evaluate and quantify the trade-off between the three approaches?
- for the same level of performance, what is the difference in required capacity between the three approaches and how can this be used to justify the choice of one approach over another?

Questions

- How much more network capacity is needed with aggregate versus per-flow handling?
- How does the complexity of per-flow handling compare to capacity costs of aggregate traffic handling?
- How sensitive are the capacity requirements to variations in delay requirements?

Introduction and Motivation

Approach

- Alternatives
 - Simulation
 - Stochastic Analysis
 - Deterministic Analysis
- Chose deterministic analysis using network calculus to provide bounds on capacity
 - Not dependent on traffic models
 - Suitable for architectural comparisons

Network Calculus

Traffic Characterization

- Arrival curves: upper bound on amount of traffic in a given interval
- Example: IETF arrival curve model

$$A(t) = \min(M + pt, b + rt)$$

- M = maximum packet size, p = peak rate, b = burst tolerance, r = sustainable rate

Network Calculus

Network Characterization

- Service curves: lower bound on amount of traffic that receives service
- Example: IETF rate-latency service curve

$$S(t) = R[t - T]^+ = \begin{cases} R(t - T) & t \geq T \\ 0 & \textit{otherwise} \end{cases}$$

- R is the guaranteed rate and T is the latency

Network Calculus

IETF Arrival and Service Curves

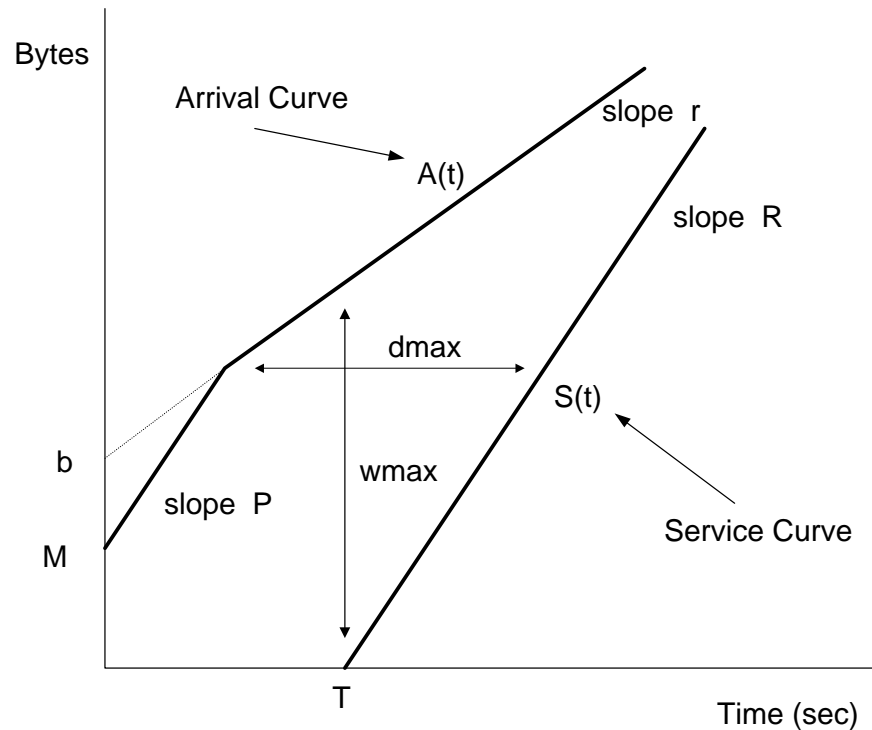

● delay bound d_{max}

● backlog bound w_{max}

Network Calculus

Traffic Handling Schemes Studied

Classification	Mechanisms	Abbreviation
Best-Effort	First-In-First-Out	FIFO
Class-Based	Strict Priority Queueing	PQ
	Class-Based Queueing	CBQ
Per-Flow	Weighted Fair Queueing	WFQ

Network Calculus

Models of Network Elements: FIFO Scheduler

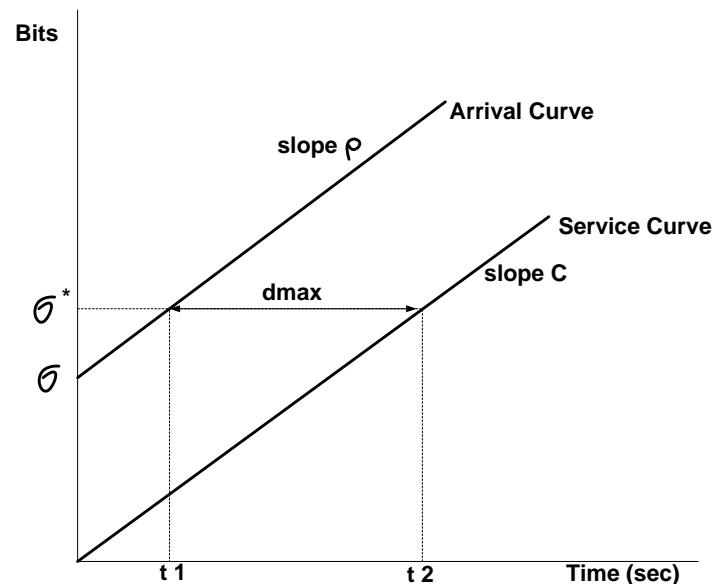

$$A(t) = \sigma + \rho t$$

$$S(t) = Ct$$

$$t_1 = \frac{\sigma^*}{C}$$

$$t_2 = \frac{\sigma^* - \sigma}{\rho}$$

$$t_2 - t_1 = \frac{\sigma^*}{C} - \left(\frac{\sigma^* - \sigma}{\rho} \right)$$

$$d_{max}^{FIFO} = \frac{\sigma}{C}$$

Network Calculus

Models of Network Elements: WFQ Scheduler

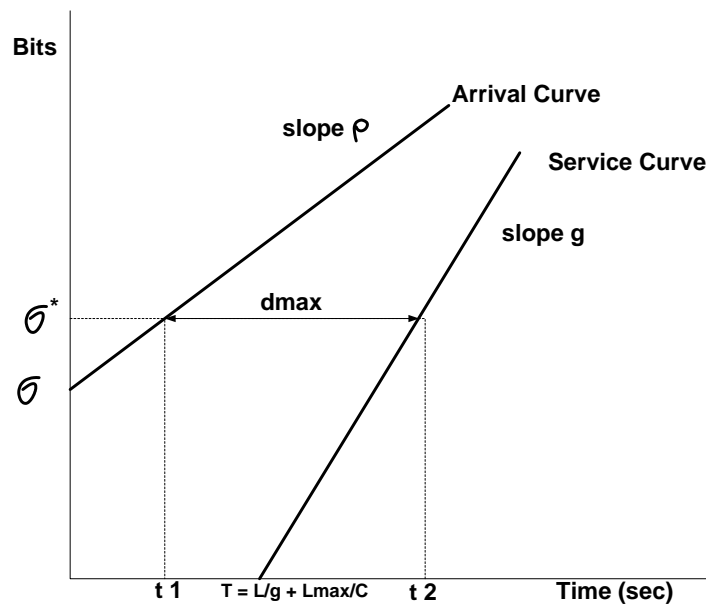

$$A(t) = \sigma + \rho t$$

$$S(t) = R(t - (L/g + L_{max}/C))$$

$$t_1 = \frac{\sigma^* - \sigma}{\rho}$$

$$t_2 = \frac{\sigma^* + L}{g} + \frac{L_{max}}{C}$$

$$d_{max}^{WFQ} = \frac{\sigma + L}{g} + \frac{L_{max}}{C}$$

Methodology

Applications

Application	RT/NRT	QoS	Avg. Rate (Mbps)	Burstiness (Bytes)	Packet Size (Bytes)
Telephony	RT	low delay	0.064	64	64
Interactive Video	RT	low delay	1.5	8000	512
E-mail	NRT	delay tolerant	0.128	3072	512
WWW	NRT	delay tolerant	1.0	40960	1500

- Email and WWW are delay-tolerant BUT may require some guaranteed bandwidth to prevent starvation

Methodology

Comparison of Capacity Requirements

- Use WFQ as reference to set network load
- Find capacity required by CBQ, PQ and FIFO to support same traffic as WFQ
- Analysis is deterministic thus delay bounds may be loose BUT we are interested in difference in capacity

Methodology

Cases Studied

- Impact of voice or www load on capacity
- Impact of growth in traffic beyond design point on delay QoS
- Projection of required capacity with annual traffic growth based on industry estimates
- Impact of changing delay QoS bounds on capacity
- Impact of changing burstiness on capacity
- Impact of uncertainty in delay parameters on capacity

Single-Link Analysis

WFQ Equations

- guaranteed rate

$$g_k^{WFQ} = \max \left\{ \frac{\sigma_k + L_k}{D_k}, \rho_k \right\}$$

- Number of sources

$$N_k = \left\lfloor \frac{w_k * C}{g_k^{WFQ}} \right\rfloor$$

Single-Link Analysis

Capacity Calculations

- WFQ Capacity

$$C^{WFQ} = \sum_{k=1}^K N_k g_k^{WFQ}$$

- CBQ

$$C^{CBQ} = \sum_{p=1}^P \sum_{k \in p} \frac{N_k \sigma_k + L_p}{D_{class\ p}}$$

Single-Link Analysis

Capacity Calculations

• PQ

$$C^{PQ} = \max_{p=1 \dots P} \left\{ \sum_{j=1}^p \sum_{k \in \text{class } j} \frac{N_k \sigma_k + L_{\max(p)}}{D_{\text{class } p}} + \sum_{j=1}^{p-1} \sum_{k \in \text{class } j} N_k \rho_k \right\}$$

• FIFO

$$C^{FIFO} = \sum_{k=1}^K \frac{N_k \sigma_k}{D_{\min}}$$

Single-Link Results

Projections on Traffic Growth

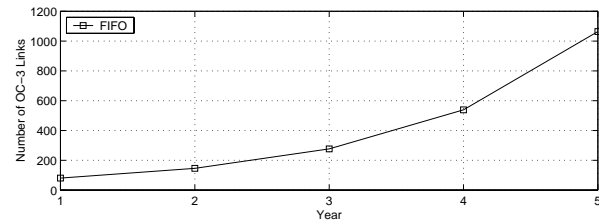
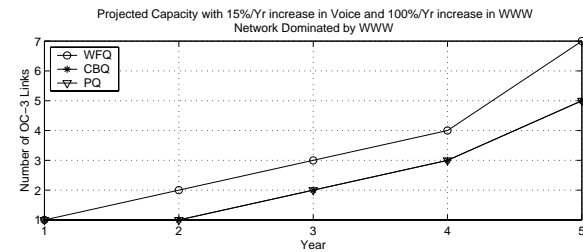
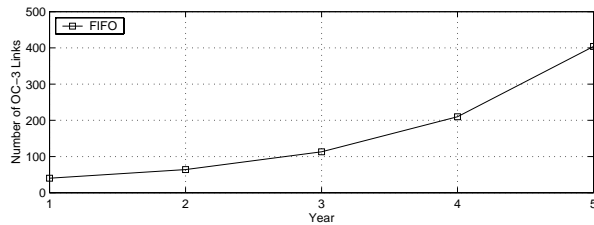
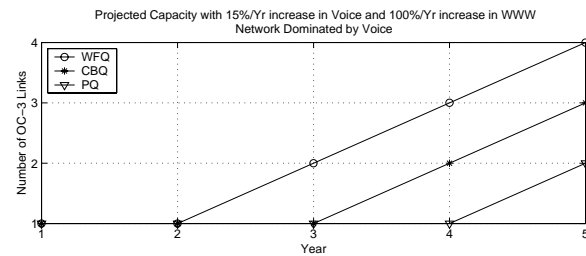

- WFQ capacity increases by factor of 4-7
- CBQ capacity increases by factor of 3-5
- FIFO capacity increases by factor of 8-13

Single-Link Results

Capacity as a function of Voice Delay

Voice Delay (sec)	C^{WFQ} (Mbps)	C^{CBQ} / C^{WFQ}	C^{PQ} / C^{WFQ}	C^{FIFO} / C^{WFQ}
0.001	121.23	1.08	0.88	99.6
0.0015	121.23	0.86	0.67	66.5
0.002	121.74	0.76	0.57	49.7
0.0025	121.64	0.7	0.5	39.8
0.003	121.57	0.66	0.46	33.29

- Increase in voice delay = decrease in capacity
- linear relationship for FIFO
- CBQ & PQ capacity comparable to WFQ

Single-Link Results

Capacity as a function of burstiness

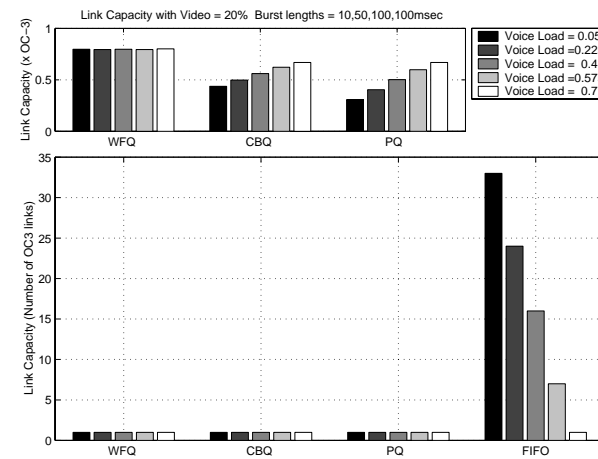
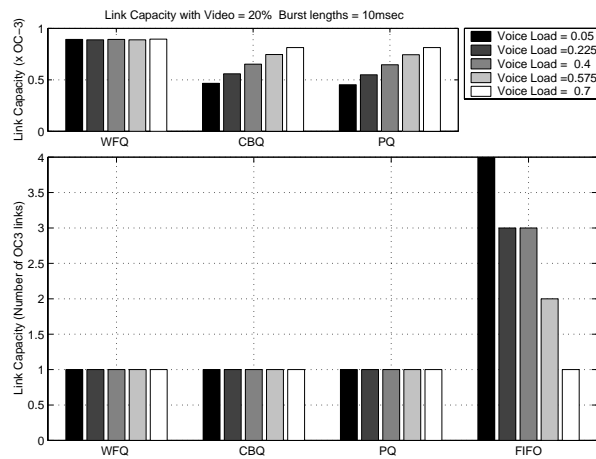

- smaller burst size = same order of magnitude capacity
- increasing Email and WWW burst size increases FIFO capacity significantly

Edge-Core Network Analysis

Edge-Core Topology

- Topology defined by # of core nodes N_{core} & # of links per core node n_{link}
- $(N_{core} - 2)$ topologies per N_{core}
- Full-mesh: $n_{link} = (N_{core} - 1)$
- Fixed # of sources per edge node

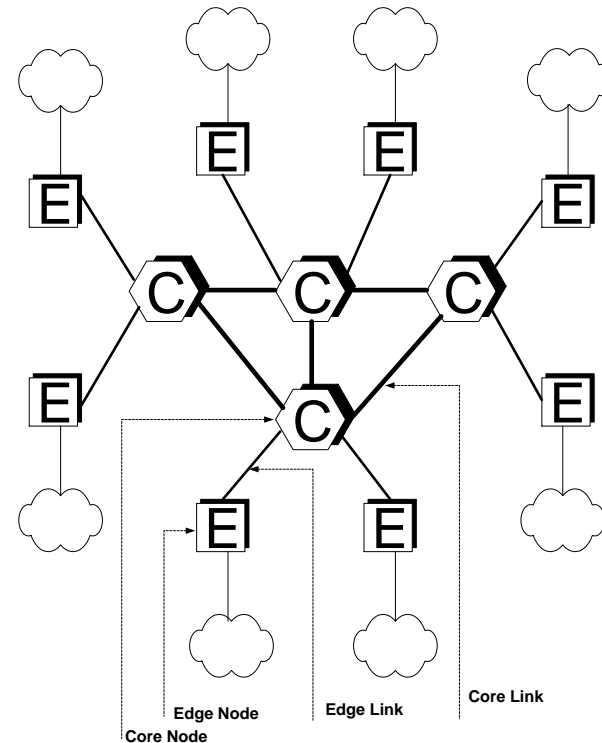

Edge-Core Network Analysis

Analysis of Capacity Requirements

- use a network with WFQ in both the edge and core as the reference
- calculate the amount of traffic that can be supported in a WFQ network
- compare the capacity required for various combinations of traffic handling schemes in the edge and core

Edge-core Network Results

Parameters

- number of edge nodes per core node
 $N_{edge} = 60/N_{core}, N_{core} = 3..20$
- routes set-up within the core using Dijkstra's shortest path algorithm
- Traffic within the core was distributed symmetrically
- maximum load on each edge link $w_T = 90\%$

Edge-Core Network Results

Network Capacity for 20-node Full-Mesh

		Core Traffic Handling			
		WFQ	CBQ	PQ	FIFO
Edge Traffic Handling	WFQ	107	201	144	1497
	CBQ	191	256	195	1818
	PQ	146	210	149	1700
	FIFO	1212	1269	1224	2318

- Network capacity in equivalent OC-3 links
- All-FIFO capacity \approx 22x all-WFQ network
- All-CBQ capacity \approx 2.5x all-WFQ network
- All-PQ capacity \approx 1.5x all-WFQ network

Edge-Core Network Results

Impact of Network Diameter with WFQ Edge

Max Hops	C^{WFQ} (x OC3)	C^{CBQ} / C^{WFQ}	C^{PQ} / C^{WFQ}	C^{FIFO} / C^{WFQ}
1 (full-mesh)	54	2.8	1.72	28.5
2	85	3.52	2.17	40.08
3	102	3.96	2.24	40.21
4	113	4.0	2.47	46.06
5	156	4.66	2.8	51.8
7	198	5.27	3.36	62.6
10	281	6.17	4.11	74.6

- utilization decreases with increasing diameter
 - WFQ: 0.73 - 0.14, CBQ: 0.25 - 0.02, FIFO: 0.025 - 0.001
 - more links => smaller diameter => higher per-node delay => smaller capacity

Edge-Core Network Results

Impact of Delay Bound with FIFO Edge

Voice Delay Bound	C^{WFQ} (Mbps)	C^{CBQ} / C^{WFQ}	C^{PQ} / C^{WFQ}	C^{FIFO} / C^{WFQ}
0.01	110	2.47	1.89	31.02
0.015	113	1.99	1.42	20.4
0.02	116	1.76	1.2	15
0.025	119	1.63	1.08	11.96
0.03	122	1.55	1.01	9.89

- 10 core nodes
- WFQ capacity increases with increasing voice delay
 - due to increased burstiness in FIFO edge
- CBQ, PQ and FIFO capacity decreases with increasing voice delay

Simplified Bounds on Capacity

Goal

- simplify capacity calculations for CBQ, PQ and FIFO
- obtain simple bounds for ratios of CBQ, PQ and FIFO capacity to WFQ capacity as functions of:
 - maximum delay bound
 - aggregate burstiness

Simplified Bounds on Capacity

Single Link

• FIFO

$$\frac{C^{FIFO}}{C^{WFQ}} = \frac{\overline{\gamma^{FIFO}}}{\overline{g^{WFQ}}}$$

$$\overline{\gamma^{FIFO}} = \frac{\sum_{k=1}^K \frac{N_k \sigma_k}{D_{min}}}{\sum_{k=1}^K N_k}$$

• CBQ

$$\frac{C^{CBQ}}{C^{WFQ}} < \frac{\overline{\gamma^{CBQ}}}{\overline{g^{WFQ}}} + \frac{\sum_{p=1}^P \frac{L_p}{D_{min}}}{\sum_{k=1}^K N_k \overline{g^{WFQ}}}$$

$$\overline{\gamma^{CBQ}} = \frac{\sum_{k=1}^K \frac{N_k \sigma_k}{D_{k,p}}}{\sum_{k=1}^K N_k}$$

Bounds on Capacity

Single Link Results for CBQ

Voice Delay Bound (sec)	$\overline{g^{WFQ}}$ (Mbps)	$\overline{\gamma^{CBQ}} / \overline{g^{WFQ}}$	C^{CBQ} / C^{WFQ}	
			Simple	Exact
0.001	0.45	0.99	1.25	1.08
0.0015	0.41	0.8	0.88	0.86
0.002	0.37	0.72	0.78	0.76
0.0025	0.34	0.66	0.71	0.7
0.003	0.31	0.64	0.68	0.66

- simple bounds accurate
- $\overline{\gamma^{CBQ}}$ can provide reasonable estimate of CBQ capacity

Capacity, Delay and Utilization

Path vs non-Path Aggregation with PQ scheduler

- Path Aggregation: aggregated flows share same end-to-end path e.g. MPLS
- non-Path Aggregation(non-PA) network:

$$D_{E2E}^{non-PA} = \frac{\sigma + L}{C} \left(\frac{M}{(1 - (M - 1)\alpha)} \right)$$

- Path Aggregation(PA) network:

$$D_{E2E}^{PA} = \frac{\sigma + L}{C} \left(\frac{(1 + \alpha)^M - 1}{\alpha} \right)$$

equations differ in multiplying factor applied to

Capacity, Delay and Utilization

Path vs non-Path Aggregation with PQ scheduler

Nodes (M)	Utilization $\alpha = 0.1$		Utilization $\alpha = 0.9$	
	non-PA	PA	non-PA	PA
1	1	1	1	1
2	2.2	2.1	20	2.9
3	3.75	3.31	*	6.51
10	100	15.7	*	147.7

- non-PA bound large when $M = 10$ and $\alpha = 0.1$
- non-PA bound not applicable for $M > 2$ and $\alpha = 0.9$
- PA can provide better utilization and delay QoS over large networks

Sensitivity Analysis

Motivation for Sensitivity Analysis

- analysis presented so far requires knowledge of the maximum delay bounds for each traffic type carried in the network
 - must consider how imperfect knowledge affects capacity
 - must consider how traffic handling mechanisms are affected by uncertainty in the delay bounds

Sensitivity Analysis

Questions

1. what is the uncertainty in the capacity requirements given the uncertainty in the delay bounds?
2. how important are the individual delay bounds for each traffic type with respect to the uncertainty in the capacity?

Sensitivity Analysis

Sensitivity Analysis of capacity requirements

$$E\{C\} = \bar{C} + \frac{1}{2} \sum_{k=1}^K \frac{\partial^2 C}{\partial \bar{D}_k^2} Var[D_k]$$

$$Var[C] = \sum_{k=1}^K \left(\frac{\partial C}{\partial \bar{D}_k} \right)^2 Var[D_k]$$

Sensitivity Analysis Results

Parameters

Type	$D_{min}(ms)$	$D_{max}(ms)$	$D_{mean}(ms)$	$Var[D](ms)^2$
Voice	1	2	1.5	0.083
Video	1	5	3.0	1.33
Email	1	100	50.5	816.75
WWW	1	200	100.5	3300.08

- uniformly-distributed delays
- overlapping distributions
- analysis possible for WFQ only

Sensitivity Analysis Results

WFQ Results

	Parameter	Voice	Video	Email	WWW
Analytic	Sensitivity (Mbps/msec)	22.75	15.13	1.12	0.336
	% Variance	2.5	17.4	58.8	21.3
Simulation	Sensitivity (Mbps/msec)	24.5	21.7	6.06	0.256
	$\sqrt{Variance}$ (Mbps)	7.18	26.4	248	238.8
	% Variance	0.04	0.6	52	48

- sensitivity highest for voice
- most variance in capacity due to email and WWW
- ranking of % variance same for analytic and simulation

Sensitivity Analysis Results

CBQ Simulation Results

Parameter	Voice	Video	Email	WWW
Sensitivity (Mbps/msec)	79.3	5.13	12	3.75
$\sqrt{Variance}(Mbps)$	23.2	9.47	497.94	392.25
% Variance	0.13	0.02	61.5	38.35

- variance in capacity due to email and WWW
- sensitivity highest for voice
- similar results for PQ

Sensitivity Analysis Results

FIFO Simulation Results

Parameter	Voice	Video	Email	WWW
Sensitivity (Mbps/msec)	2820	182	0.679	0.184
$\sqrt{Variance}$ (Mbps)	825.8	336.98	64.17	68.65
% Variance	84.8	14.1	0.5	0.6

- sensitivity highest for voice
- variance in capacity due to voice and video

Lessons Learned

- Can quantify comparison of capacity requirements
 - CBQ & PQ network capacity \approx WFQ capacity
- importance of network architecture in comparing traffic handling approaches
 - edge-core traffic handling combinations
 - path vs non-path aggregation
- sensitivity analysis helps to identify critical parameters affecting capacity requirements
- quantifying complexity vs cost of capacity non-trivial task

Significance of Results

Network Architecture

- all-WFQ = small capacity + high complexity
- Combination of WFQ, CBQ, PQ = small capacity + medium to high complexity
- all-FIFO = huge capacity + least complexity
- FIFO + (WFQ, CBQ, PQ) = moderate capacity + medium to high complexity

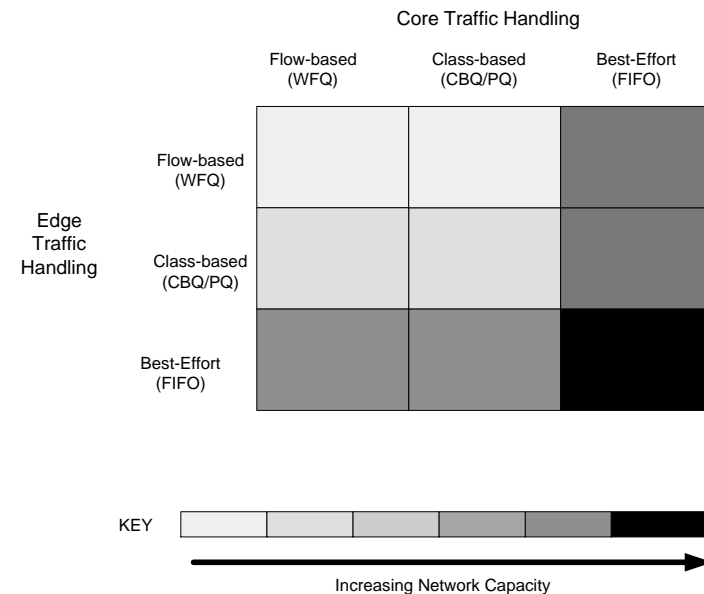

Significance of Results

Network Design

- Simplified Bounds on capacity
 - use simpler WFQ analysis to obtain estimates of CBQ, PQ and FIFO capacity
- Path-aggregation analysis
 - relationship between capacity, utilization and delay
 - can be used to illustrate benefits of architectures such as MPLS that use path-aggregation

Significance of Results

Sensitivity Analysis

- Planning and Forecasting
 - impact of changes in traffic patterns on capacity
- Service Provisioning
 - types of services possible with existing capacity
- Network Management
 - choice of parameters for desired service

Summary of Contributions

- developed methodology for comparing different traffic handling approaches
- demonstrated equivalence of class-based schemes and flow-based schemes wrt capacity requirements
 - Per-flow traffic management vs Differentiated services debate
- developed sensitivity analysis for long-term network planning
- extended the application of Network Calculus in addressing a significant networking problem

Future Work

- use of stochastically bounded traffic models
- obtaining better bounds on utilization for networks that use aggregate traffic handling
- extend work on capacity bounds
- sensitivity analysis
 - obtaining an analytic solution using order statistics
 - use of global sensitivity analysis such as the importance measures