

Multipath Routing Protocol for Rapidly Deployable Radio Networks

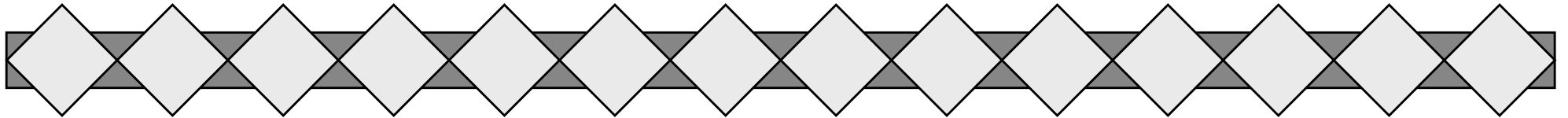

Fadi Wahhab
December 19, 1998

Outline



- ◆ **Overview**
 - ◆ **Example**
 - ◆ **Simulation Environment**
 - ◆ **Simulation Results**
-

Overview



- ◆ **Extended Bellman Ford**
 - ◆ **Incremental Dumps**
 - ◆ **Multiple Path**
 - ◆ **Split Horizon**
 - ◆ **Holdoff before adding new neighbors**
-

Example

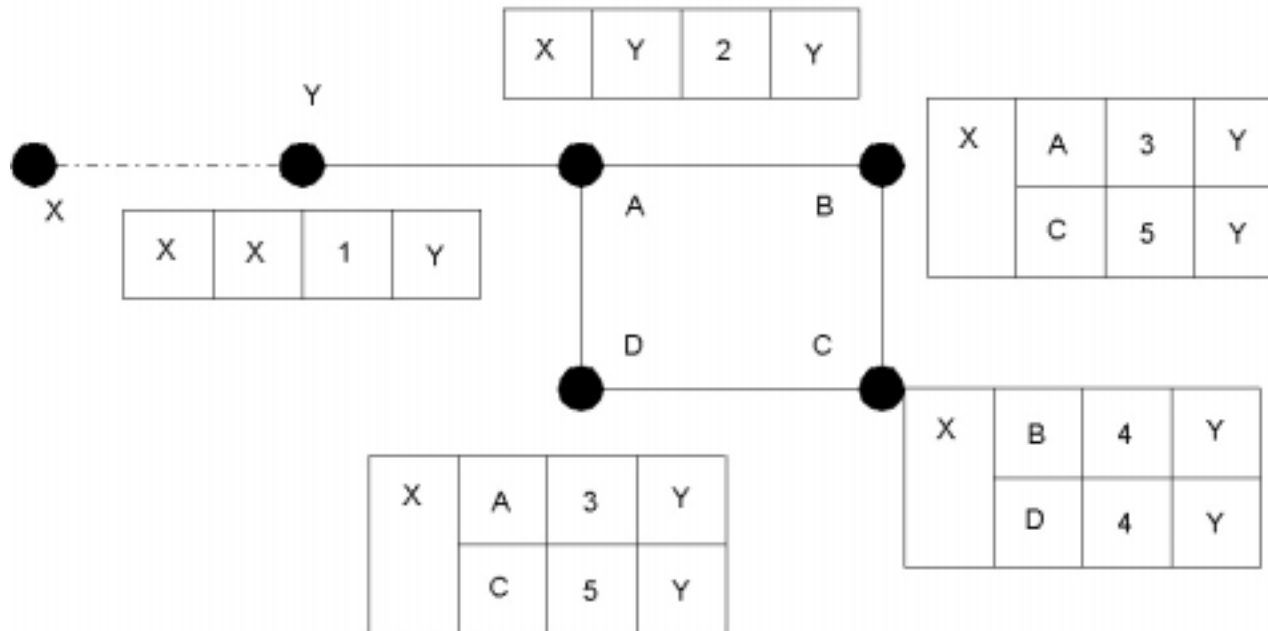

Simulation Environment



- ◆ **Movement Model**
 - ◆ **Communication Model**
 - ◆ **Medium Access Control**
 - ◆ **Physical Layer Model**
-

Results with different Hello intervals

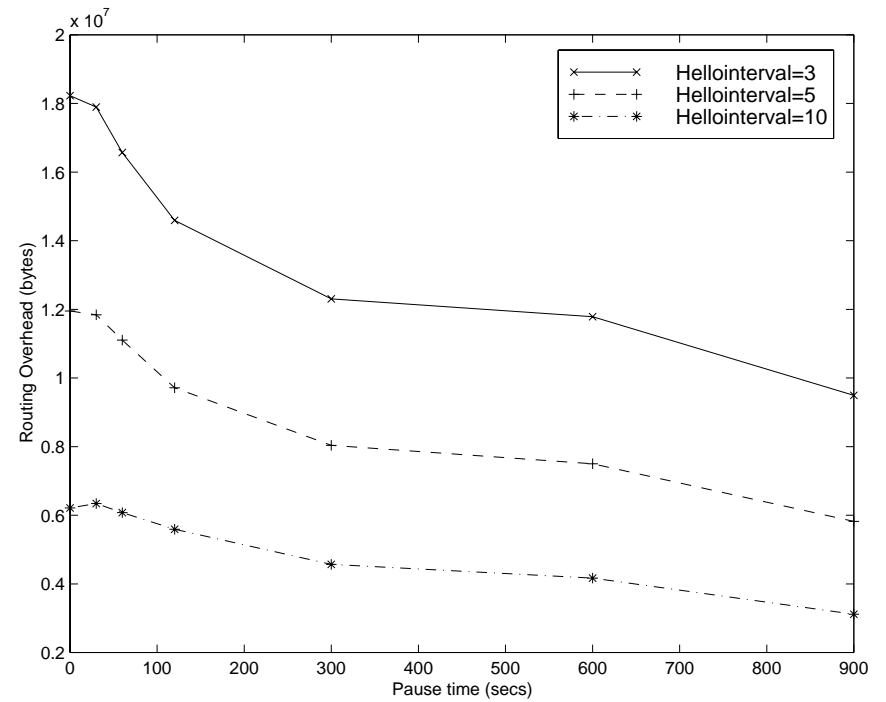
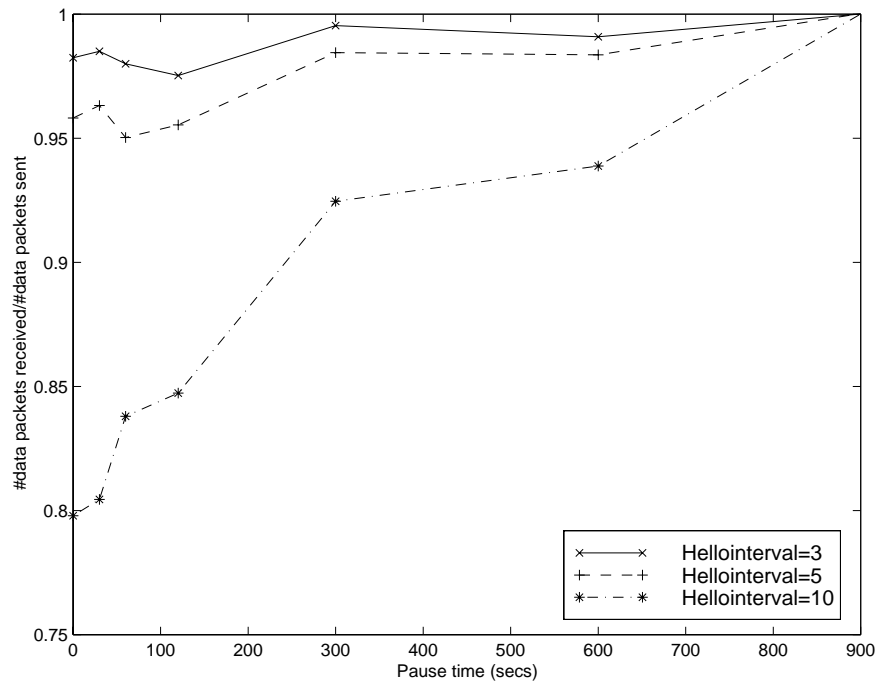

Results with varying load

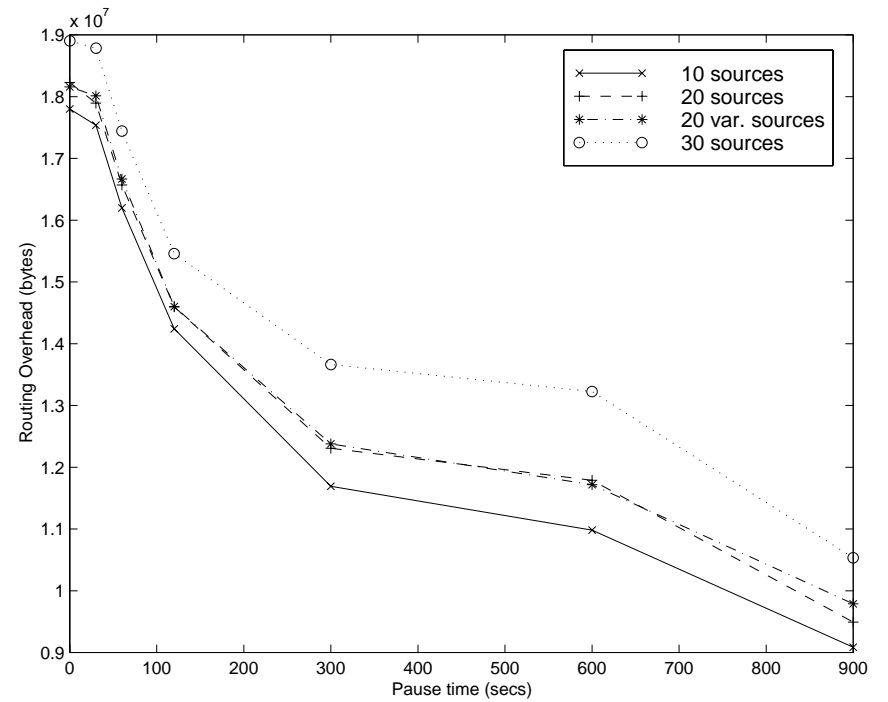
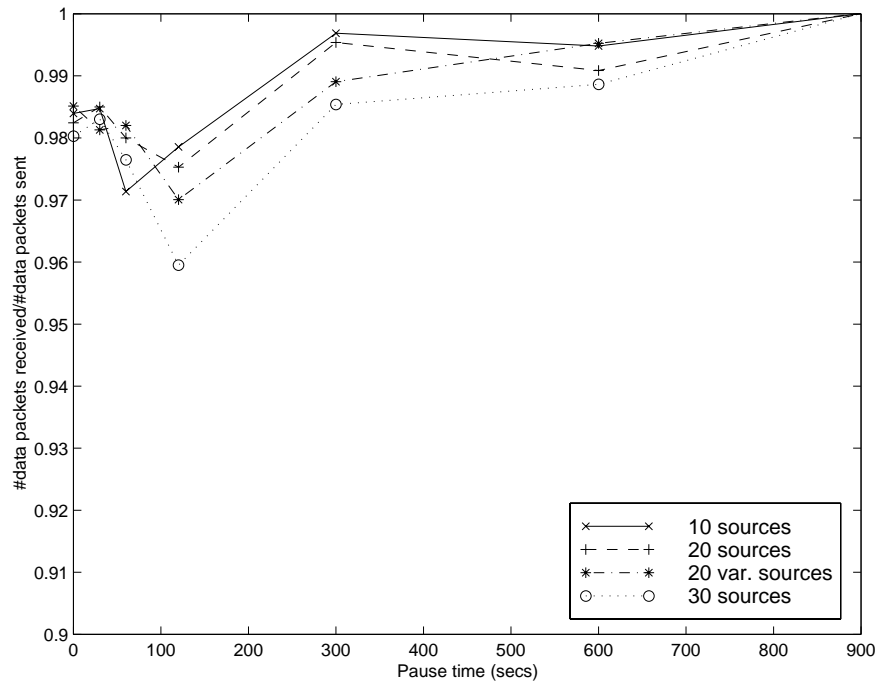

Different Protocols Using 20 sources

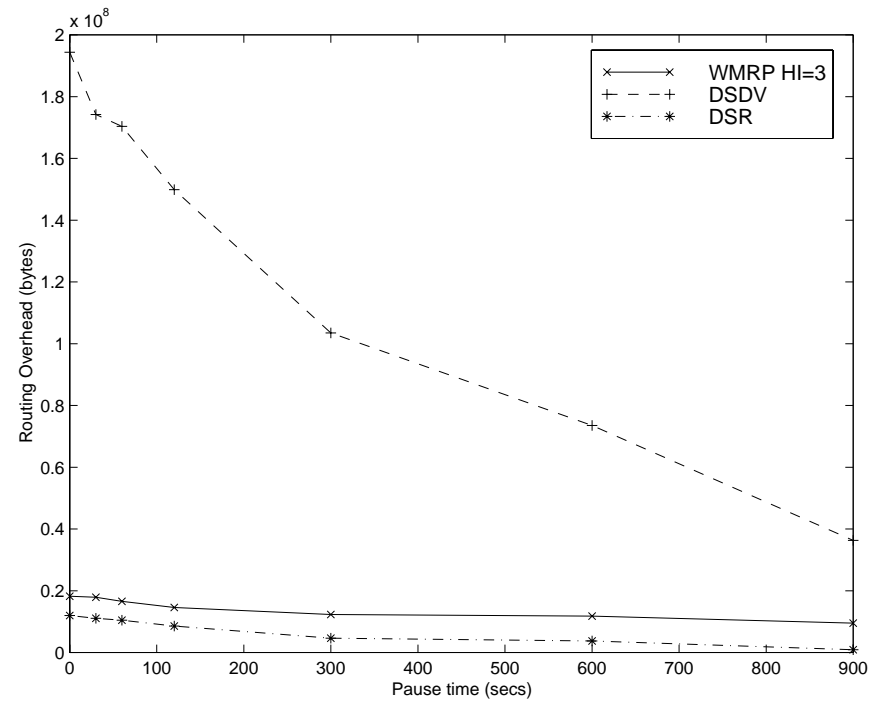
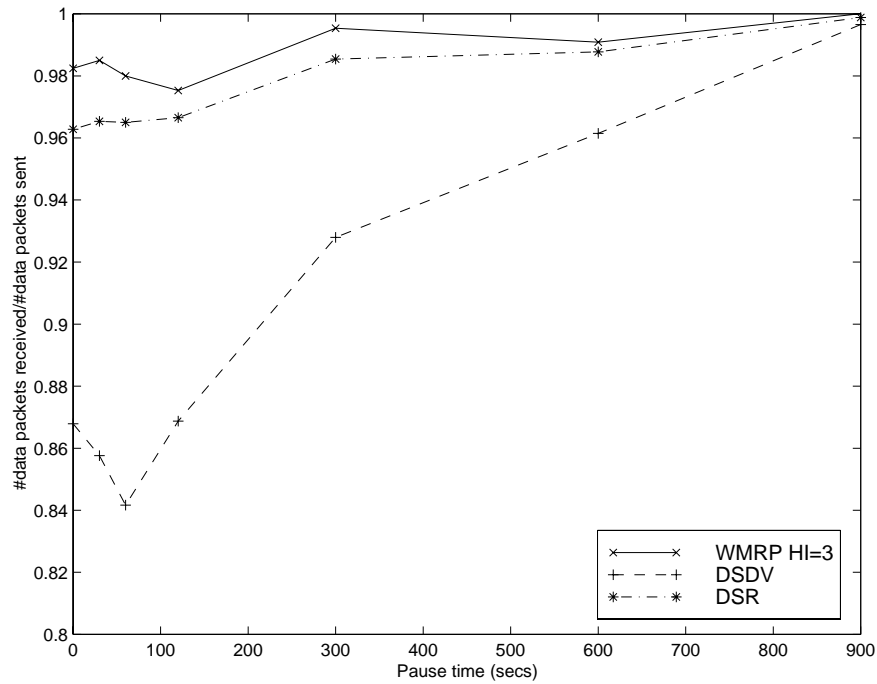

Different Protocols Using 20 var. sources

